



EN Operating instructions. pages 1 to 4
Translation of the original operating instructions

Content

1 About this document

1.1 Function 1

1.2 Target group: authorised qualified personnel. 1

1.3 Explanation of the symbols used 1

1.4 Appropriate use 1

1.5 General safety instructions 1

1.6 Warning about misuse 1

1.7 Exclusion of liability 2

2 Product description

2.1 Ordering code 2

2.2 Special versions. 2

2.3 Destination and use 2

2.4 Technical data 2

3 Mounting

3.1 General mounting instructions 2

3.2 Dimensions 3

4 Electrical connection

4.1 General information for electrical connection. 3

4.2 Contact variants. 3

4.3 Switch travel diagrams. 3

5 Set-up and maintenance

5.1 Functional testing. 3

5.2 Maintenance 3

6 Disassembly and disposal

6.1 Disassembly. 3

6.2 Disposal. 3

7 Appendix

7.1 EC Declaration of conformity 4

1. About this document

1.1 Function
This operating instructions manual provides all the information required for the mounting, set-up and commissioning to ensure the safe operation and disassembly of the safety switchgear. The operating instructions must be available in a legible condition and a complete version in the vicinity of the device.

1.2 Target group: authorised qualified personnel
All operations described in this operating instructions manual must be carried out by trained specialist personnel, authorised by the plant operator only.

Please make sure that you have read and understood these operating instructions and that you know all applicable legislations regarding occupational safety and accident prevention prior to installation and putting the component into operation.

The machine builder must carefully select the harmonised standards to be complied with as well as other technical specifications for the selection, mounting and integration of the components.

1.3 Explanation of the symbols used

 **Information, hint, note:**
This symbol is used for identifying useful additional information.

 **Caution:** Failure to comply with this warning notice could lead to failures or malfunctions.
Warning: Failure to comply with this warning notice could lead to physical injury and/or damage to the machine.

1.4 Appropriate use
The product must be exclusively used in accordance with the versions listed below or for the applications authorised by the manufacturer. Detailed information regarding the range of applications can be found in the chapter "Product description".

1.5 General safety instructions
The user must observe the safety instructions in this operating instructions manual, the country-specific installation standards as well as all prevailing safety regulations and accident prevention rules.

 Further technical information can be found in the Schmersal catalogues or in the online catalogue on the Internet: www.schmersal.net.

The information contained in this operating instructions manual is provided without liability and is subject to technical modifications.

There are no residual risks, provided that the safety instructions as well as the instructions regarding mounting, commissioning, operation and maintenance are observed.

1.6 Warning about misuse

 In case of inadequate or improper use or manipulations of the component, personal hazards or damage to machinery or plant components cannot be excluded.

1.7 Exclusion of liability

We shall accept no liability for damages and malfunctions resulting from defective mounting or failure to comply with this operating instructions manual. The manufacturer shall accept no liability for damages resulting from the use of unauthorised spare parts or accessories.

For safety reasons, invasive work on the device as well as arbitrary repairs, conversions and modifications to the device are strictly forbidden; the manufacturer shall accept no liability for damages resulting from such invasive work, arbitrary repairs, conversions and/or modifications to the device.

2. Product description

2.1 Ordering code

This operating instructions manual applies to the following types:

TQ 700-① S-②-③

| No. | Option | Description |
|-----|--------|-------------------------------|
| ① | 11 | 1 NO/1 NC contacts |
| | 20 | 2 NO contacts |
| | 02 | 2 NC contacts |
| ② | | Traction force 88 N |
| | 40N | Traction force 40 N |
| ③ | | Cable entry M20 |
| | ST | Connector plug M12 (A-coding) |



Only if the information described in this operating instructions manual are realised correctly, the compliance with the Low Voltage Directive is maintained.

2.2 Special versions

For special versions, which are not listed in the order code below 2.1, these specifications apply accordingly, provided that they correspond to the standard version.

2.3 Destination and use

Pull-wire switches are used to give signals to start machines and to open or close electrically-driven doors and gates. If the pull-wire is pulled, the switching function of the pull-wire switch is activated.

2.4 Technical data

| | |
|---|---|
| Standards: | IEC/EN 60947-5-1 |
| Enclosure: | thermoplastic |
| Cover: | thermoplastic |
| Protection class: | IP67 to IEC/EN 60529 |
| Protection class: | II |
| Degree of pollution: | 3 |
| Contact material: | Silver |
| Switching system: | slow action with double break, NC contact with positive break ⊖ |
| Connection: | screw terminal, connector plug M12 |
| Cable section: | 2.5 mm ² (incl. conductor ferrules) |
| Cable entry: | 1 x M20 x 1.5 |
| Rated impulse withstand voltage U_{imp} : | |
| - screw terminal: | 6 kV |
| - connector plug M12: | 0.8 kV |
| Rated insulation voltage U_i : | |
| - screw terminal: | 500 V |
| - connector plug M12: | 50 V |
| Thermal test current I_{the} : | 10 A |
| Rated operating current/voltage I_e/U_e : | 4 A/230 VAC, 4 A/24 VDC |
| Utilisation category: | AC-15, DC-13 |
| Required short-circuit current: | 1000 A |
| Max. fuse rating: | 6 A gG D-fuse (EN 60269-1) |
| Ambient temperature: | -25 °C ... +70 °C |
| Relative humidity: | 30 ... 95%, no condensation, no icing |
| Mechanical life: | >1 million operations |
| Traction force F: | 88 N (± 15 %) |
| - version TQ 700-...S-40N: | 40 N (± 15%) |

3. Mounting

3.1 General mounting instructions

The fitting may only be carried out by authorised personnel. The enclosure can be fixed by means of 4 mounting holes. The pull-wire switch must be fitted vertically. Pull wire with ball available as accessory.

Vertical mounting

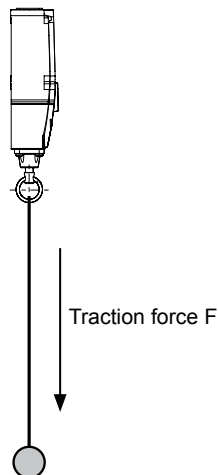

3.2 Dimensions

All measurements in mm.

TQ 700 S

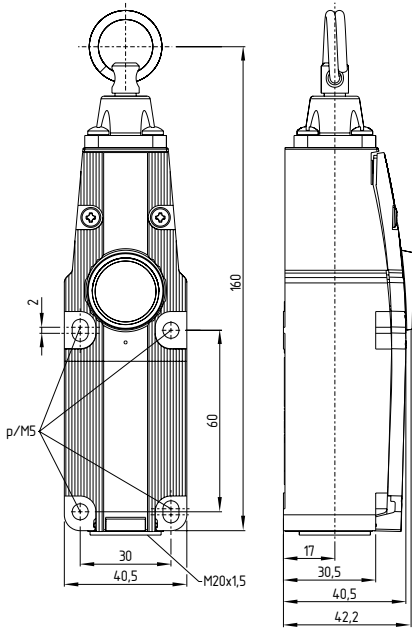

4. Electrical connection

4.1 General information for electrical connection



The electrical connection may only be carried out by authorised personnel in a de-energised condition.

For cable entries the dust cap must be removed and a suitable M20 x 1.5 cable gland (sold separately) to use with appropriate protection class. To open the cover, the cover screws must be loosened. When wiring, please ensure that no cables are located within the range of the lever system. After wiring, the inside of the switch must be imperatively cleaned (e.g. removal of cable residues), considering that foreign bodies can affect the switching behaviour. Then tighten the cover screws evenly with a torque of 0.5 Nm.

4.2 Contact variants

The symbols are shown for the switch in non-actuated condition.

TQ 700-11S

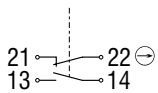

TQ 700-02S

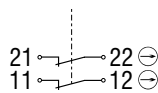

TQ 700-20S

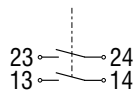

Connector

TQ 700-11S-...-ST

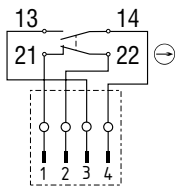

TQ 700-02S-...-ST

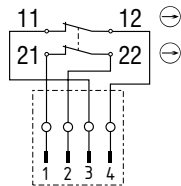

TQ 700-20S-...-ST

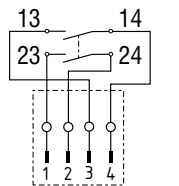

Key

⊖ Positive break NC contact

4.3 Switch travel diagrams

TQ 700-11S

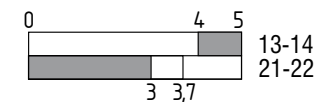

TQ 700-02S

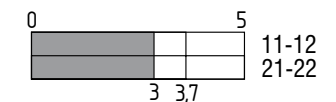

TQ 700-20S

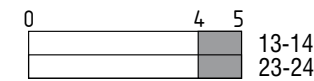

TQ 700-11S-40N

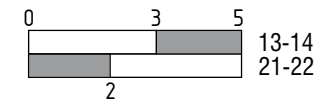

TQ 700-02S-40N

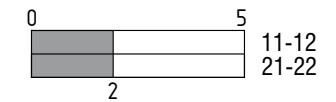

TQ 700-20S-40N

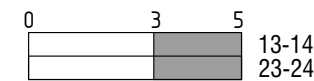

5. Set-up and maintenance

5.1 Functional testing

The function of the component must be tested. The following conditions must be previously checked and met:

1. Correct fixing of the pull-wire switch
2. Check the integrity of the cable entry and connections
3. Check the switch enclosure for damage
4. Check the functionality of the switch by actuating the wire

5.2 Maintenance

A regular visual inspection and functional test, including the following steps, is recommended:

1. Check the functionality of the switch by actuating the wire
2. Check the cable entries and the wire connections
3. Remove particles of dust and soiling

Damaged or defective components must be replaced.

6. Disassembly and disposal



6.1 Disassembly

The switch must be disassembled in a de-energised condition only.

6.2 Disposal

The switch must be disposed of in an appropriate manner in accordance with the national prescriptions and legislations.

7.1 EC Declaration of conformity

| | | |
|--|--|--|
| EC Declaration of conformity | |  |
| Translation of the original Declaration of Conformity | | ACE Schmersal Eletroneletrônica Industrial Ltda. Av. Brasil, nº 815 Jardim Esplanada CEP: 18550-000 Boituva – SP Brasil Internet: www.schmersal.com.br |
| We hereby certify that the hereafter described products both in their basic design and construction conform to the applicable European Directives. | | |
| Name of the component: | | TQ 700 S |
| Description of the component: | | Pull-wire switches |
| Relevant EC-Directives: | | 2006/95/EG EC Low Voltage Directive |
| Place and date of issue: | | Boituva, 8 July 2014 |
| | |  |
| | | Authorised signature Marco Antonio De Dato Head of Engineering and Design |

TQ700S-E-EN



The currently valid declaration of conformity can be downloaded from the internet at www.schmersal.net.



K.A. Schmersal GmbH & Co. KG
Mödinghofe 30, D - 42279 Wuppertal
Postfach 24 02 63, D - 42232 Wuppertal

Phone +49 - (0)2 02 - 64 74 - 0
Telefax: +49 - (0)2 02 - 64 74 - 1 00
E-Mail: info@schmersal.com
Internet: <http://www.schmersal.com>

Production site:
ACE Schmersal
Eletroneletrônica Industrial Ltda.
Av. Brasil, nº 815
Jardim Esplanada – CEP: 18550-000, Boituva – SP
Brasil
Phone +55 - (0)15 - 32 63 - 9866
Fax +55 - (0)15 - 32 63 - 9890
E-Mail: vendas@schmersal.com.br
Internet: <http://www.schmersal.com.br>